

# Short Shifter

## Installation Instructions

### For 2006-15 Miata, 6-speed Manual Transmission

PART# 994-060

#### Required tools:

- 10mm deep socket
- Long extension
- Ratchet
- Small flathead screwdriver
- Phillips-head screwdriver
- 3mm Allen Wrench
- Medium Strength Thread Locker (Blue Loc-Tite)
- High-Temp Grease (White Lithium grease or Wheel Bearing grease will work equally well)

**IMPORTANT NOTE: This shifter retains the factory reverse-lockout feature. YOU NEED TO PUSH DOWN FIRST, THEN MOVE LEFT, THEN MOVE UP TO ENGAGE REVERSE.**

#### Instructions

- 1) Engage the emergency brake. Then twist the shift-knob counter-clockwise to remove it. Figure 1.



- 2) Carefully pull up on the emergency-brake boot to disconnect it from the center console panel. Then slide the boot up and off of the emergency-brake handle. Figure 2.



# Installation Instructions

- 3) Use a screwdriver to remove the plastic change holder. Figure 3.



Figure 3



- 4) Remove two phillips-headed screws under the change holder. Figure 4.



Figure 4

- 5) Slide the cupholder cover back. Remove the floor of the first cupholder. Figure 5.

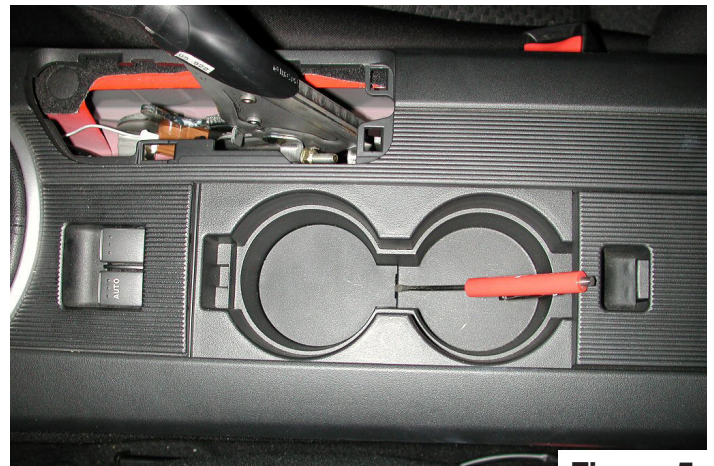
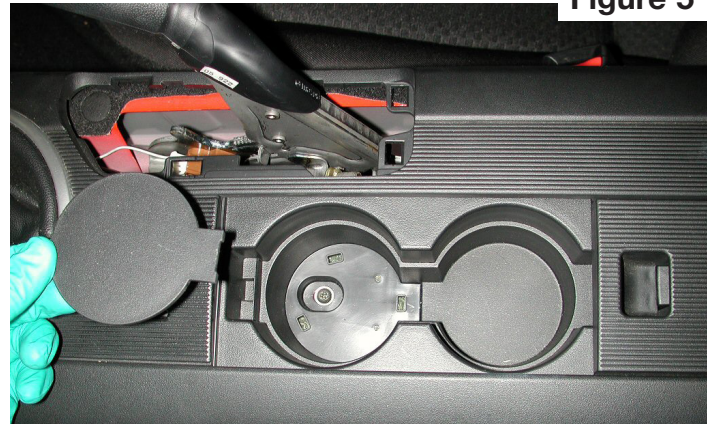
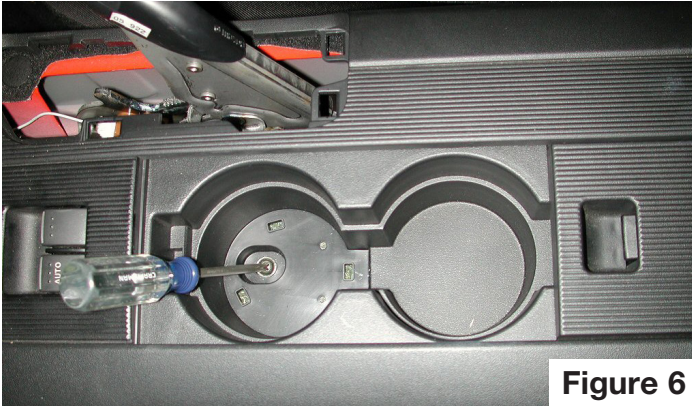

Figure 5



- 6) Remove the screw under the front cupholder.  
Figure 6.

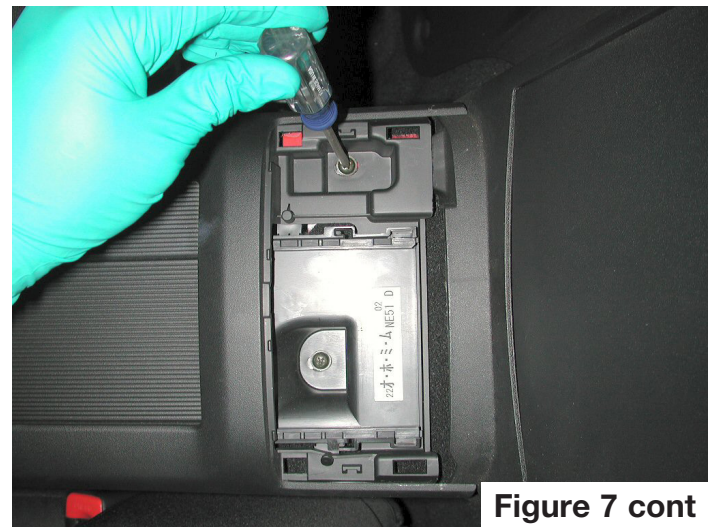

**Figure 6**

- 7) Remove the rear cover panel. Slide the cupholder cover forward. Remove the two screws that were under the rear cover panel. Figure 7.



**Figure 7**



**Figure 7 cont**

- 8) Reach through the hole for the plastic change holder near the radio and grab the center console. Pull straight up to disconnect it from the dashboard. Figure 8.



**Figure 8**

## Installation Instructions

- 9) Lift the center console 6 to 8 inches and slide a hand underneath. Disconnect the power window switch harness connector. Squeeze the tab to release the connector. Figure 9.



Figure 9



10. Remove the center console panel and set it aside. Figure 10.



Figure 10

11. Use a small flathead screwdriver to disengage the plastic harness retainer on the right rear upper shift boot stud. Pull up with the tab pushed out and slide the retainer off of the bolt. Figure 11.

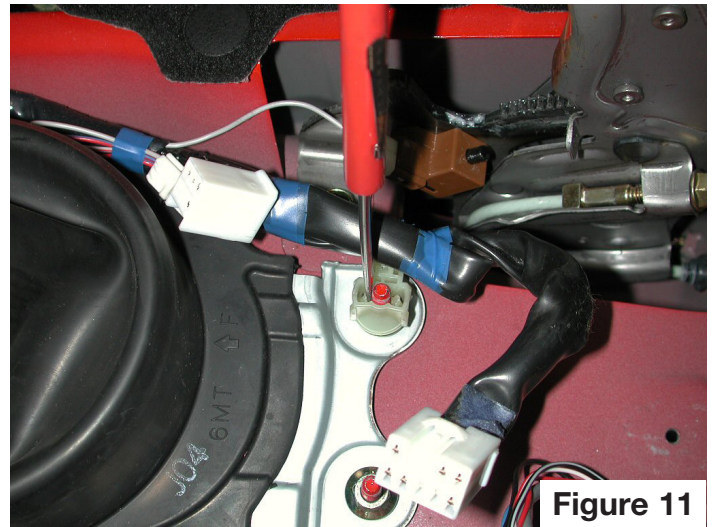

Figure 11

12. Use a 10mm socket to remove the four nuts securing the upper shifter boot. If there is a cylinder-shaped foam piece on top of the shift boot remove and save it. Then remove the upper shift boot. Figure 12.

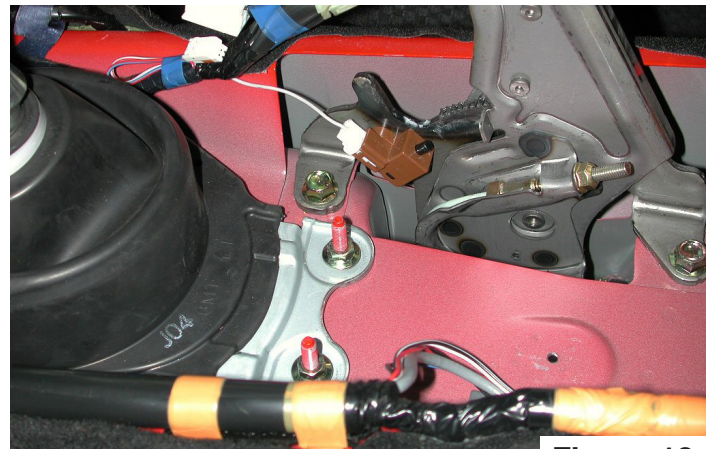

Figure 12





Figure 12 cont.



13. Pull up around the circumference of the lower shift boot to dislodge it from the transmission tunnel. Then pull it off of the shifter. Figure 13.

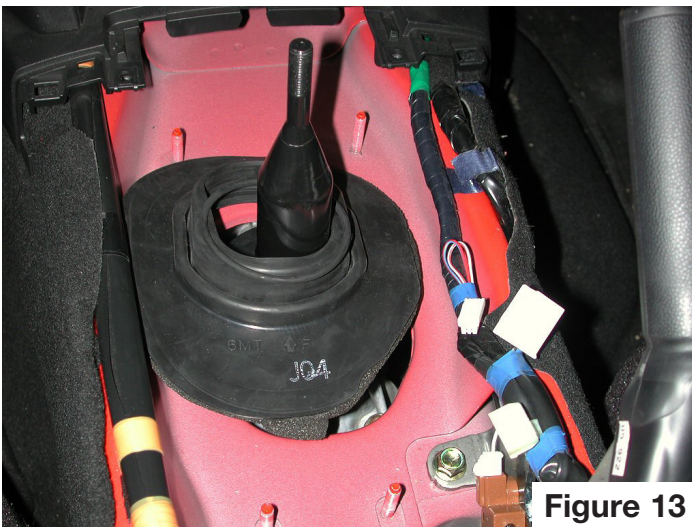

Figure 13

14. Confirm that the emergency brake is still engaged so that the vehicle cannot roll. Then, shift the transmission into the neutral position. Use a 10mm socket and a ratchet to remove the three bolts holding the reverse lockout collar to the shift turret (this collar also holds the shifter in place). SLOWLY lift the shifter STRAIGHT UP out of the shifter turret.

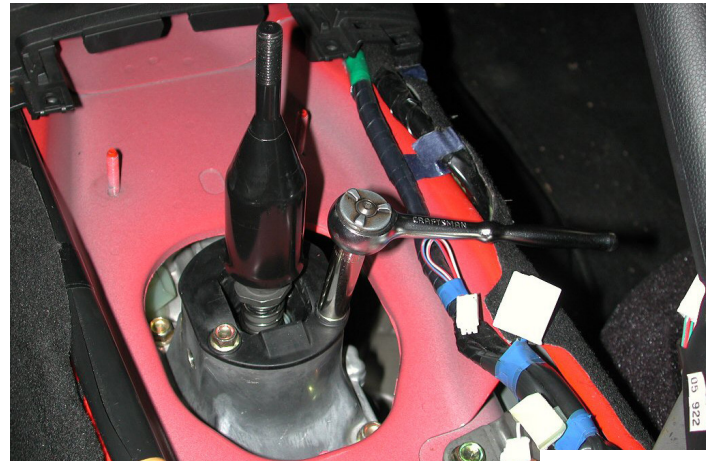

Figure 14



15. Turn the black shifter ball bushing slightly so that there is a gap between the metal of the shifter and the bushing. Stick the flat blade of the screwdriver through the hole in the bottom of the shifter cup. Use the flat edge to pop the black plastic shifter ball bushing off of the shifter ball. It should come off relatively easily. If it does not, move the black shifter ball bushing slightly and try again. Figure 15.

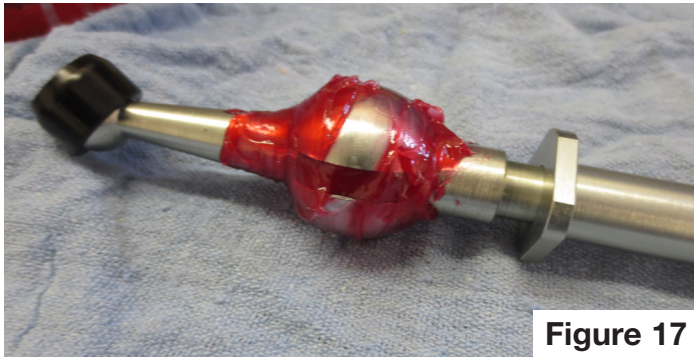

Figure 15

16. Disconnect the reverse lockout collar from the factory shifter assembly. Its held to the rest of the shifter assembly by two square retaining tabs. Push outward just above each tab and pull upward.

## Installation Instructions

17. Transfer the bushing to the new shifter by placing it on a flat surface and pressing the new shifter down into the cup of the bushing while tilting the shifter slightly. Pack grease into the grooves on the large pivot ball. Lightly grease the rest of the large pivot ball on the shifter assembly. Figure 17.



18. Apply medium-strength thread locker to both set screws and install into the shifter spacer adapter flush with the chamfered recess in the side of the adapter. Pack high-temperature grease all around the set screws inside the adapter and a light coating on the plastic bushing cup surface. Figure 18.

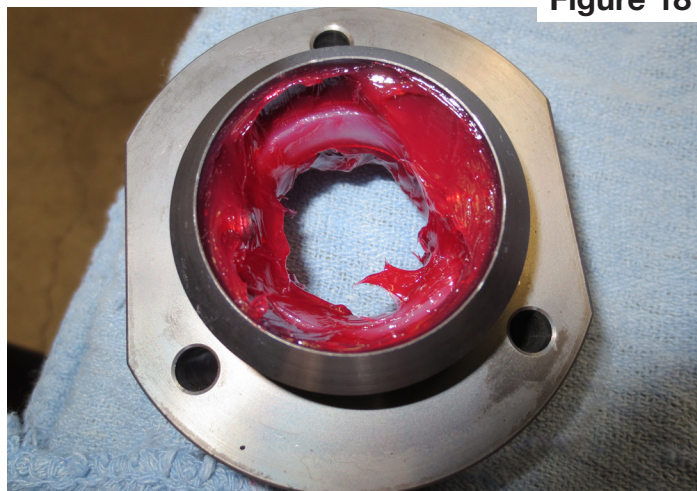
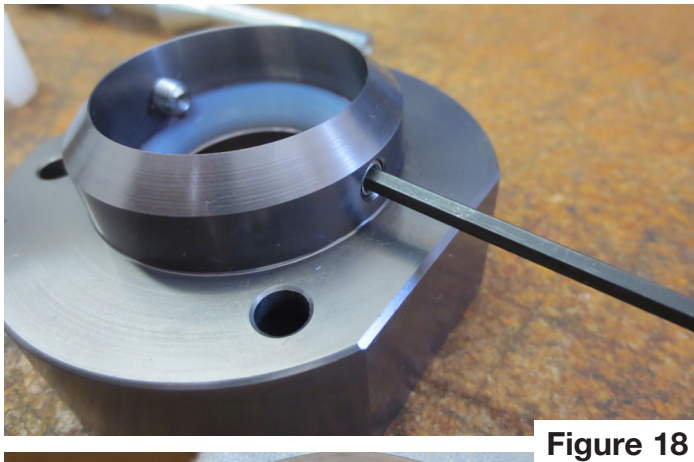

19. Locate the provided grey lower shifter bushing. Place the new lower shifter bushing into the factory shifter turret, making sure that the two metal locating pins fit into the two larger notches in the lower shifter bushing. The cup of the lower shifter bushing will face upward and will have two smaller notches in it. Make sure that the small notches are facing upward. Lightly grease the cup surface of the plastic bushing.

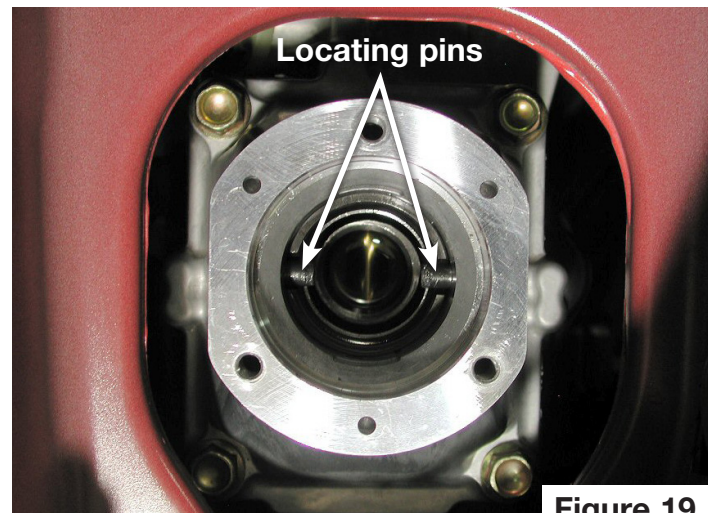
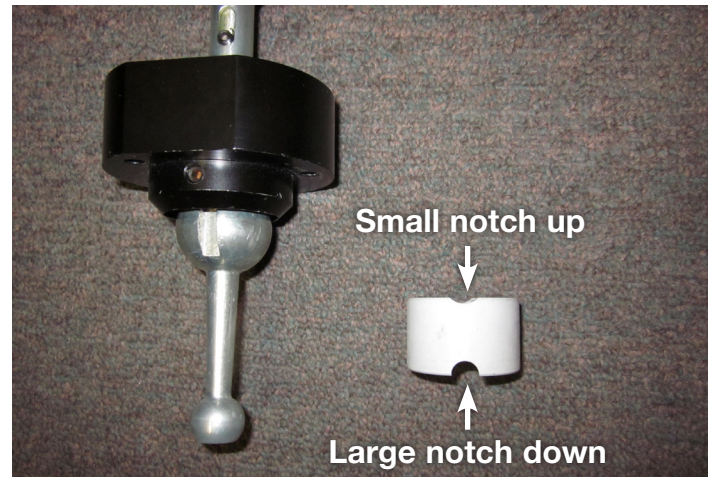

20. Take the shifter assembly and gently guide it straight down into the transmission. The plastic bushing on end of the shifter should slide easily into the cup in the shift turret and the shifter ball should rest on top of the plastic bushing you installed. Next guide the shift spacer adapter over the top and ensure the set screws line up with the slots in the shifter pivot ball. Figure 20.

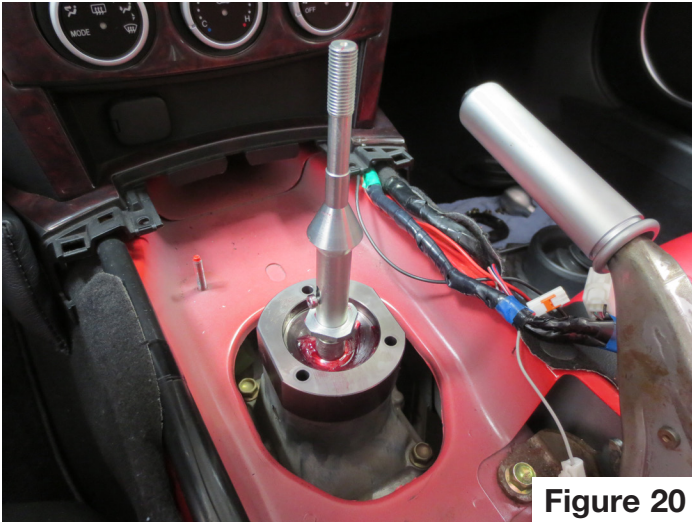

**Figure 20**

21. Install the lockout plate on top of the spacer adapter. Locate the three provided hex-head bolts. Drop a bolt into each of the three holes in the top of the shifter. Tighten each bolt to 7.5 ft. lbs. or 90 in. lbs. Figure 21.



**Figure 21**

22. Reinstall the lower shift boot. Stretch it around the shifter adapter so that it sits low enough to seal the hole for the shifter in the body. Figure 22.

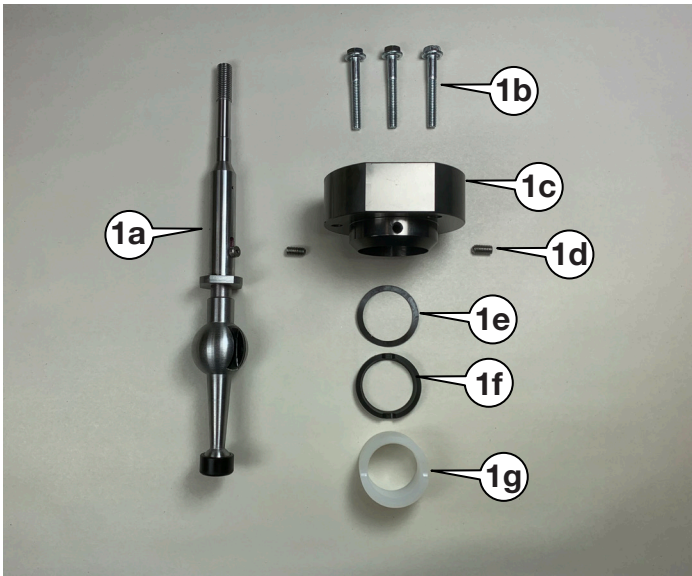

**Figure 22**

24. Then reinstall the center console, remembering to hook up the power window switch connector before reinstalling the five screws: two at the coin tray, one in the cupholder and two at the rear. Reinstall the cupholder bottom and the coin tray. Finally, reinstall the shift knob. Screw it all the way down to avoid having the knob turn or having the shift lever exposed.
25. Enjoy your new Cobalt Short Shifter!

# Installation Instructions

## Kit Contents



Ref	Description	Quantity
1a	Shifter assembly	1 each
1b	Bolts	3 each
1c	Adapter block	1 each
1d	Set screws	2 each
1e	Wavy washer	1 each
1f	Black upper bushing	1 each
1g	White adapter bushing	1 each

**Designed and Distributed by Moss Motors, Ltd.**

*For questions or comments please contact:*

**Moss Motors, Ltd.**  
440 Rutherford Street, Goleta, California 93117  
In the US & Canada Toll Free (800) 667-7872  
LOCAL (805) 681-3400 FAX (805) 692-2510



**Moss Europe Ltd.**  
Hampton Farm Industrial Estate  
Hampton Road West, Hanworth Middlesex, TW13 6DB  
In the UK: 020-8867-2020 FAX: 020-8867-2030